

Doors

ASL's Door series has been designed to suit a wide range of operations including hinged, top hung and bottom sliding. With a range of hardware components also available, our door components can also be used to create bi-folds and pivot doors. Designed to give sharp, clean architectural lines these doors have been widely used in banks, apartments, schools and government spaces. Be sure to check out of "Door Assembly Guide" later in this guide which has been put together to ensure these doors are correctly assembled on site by our customers.

- Stile widths available include 75mm, 100mm & 125mm
- Rails and Transoms include 75mm, 100mm & 150mm
- Easily accommodates 12.38 Laminated glass
- Top Hung and Bottom sliding rails available
- Variety of seals available to ensure great acoustic performance

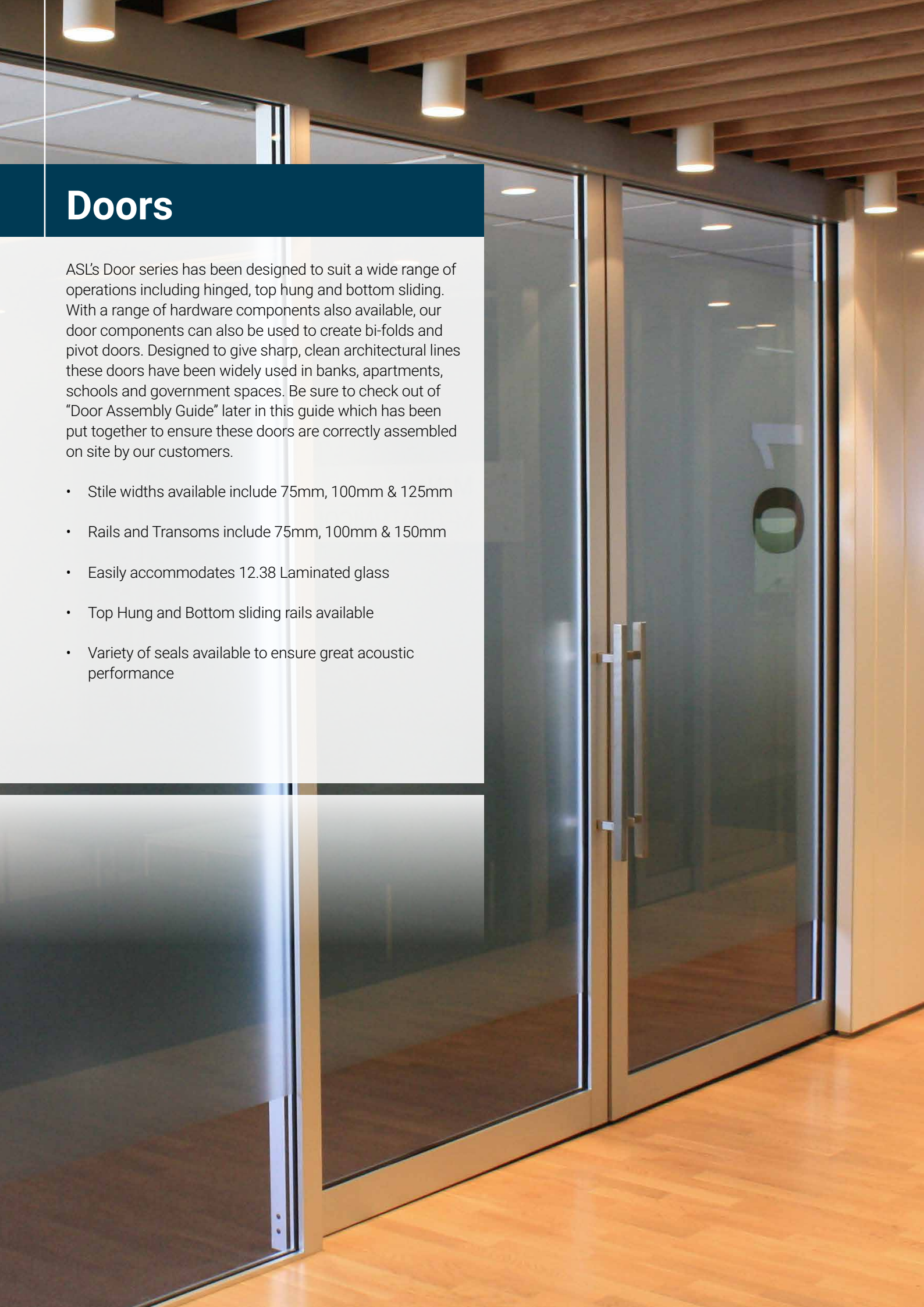

Standard Suite Profiles - Suits all ASL Systems

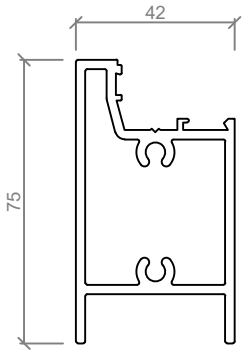

ASL 605
75mm TOP & BOTTOM RAIL

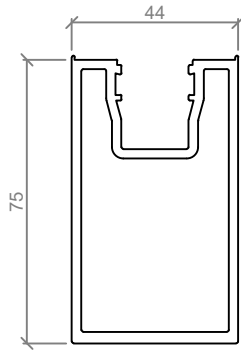

ASL 615
75mm HINGE STILE

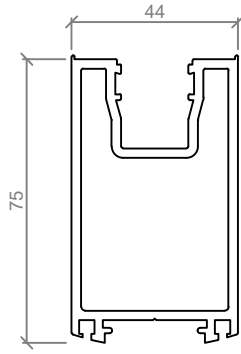

ASL 620
75mm LOCKSET STILE

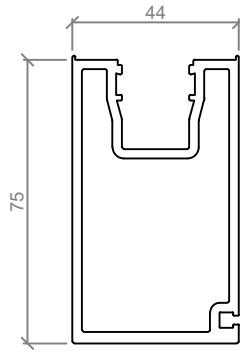

ASL 625
75mm CLOSING STILE

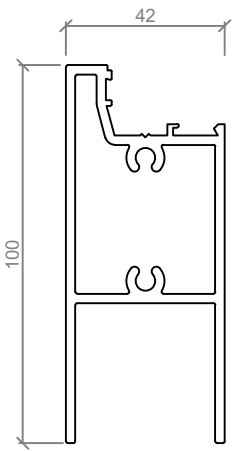

ASL 645
100mm TOP & BOTTOM RAIL

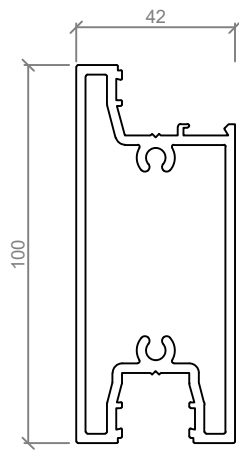

ASL 670
100mm TRANSOM

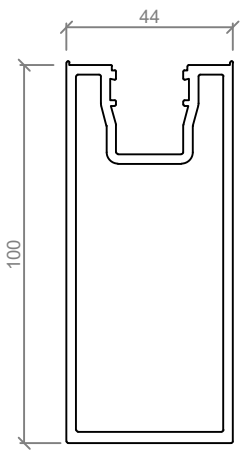

ASL 655
100mm HINGE STILE

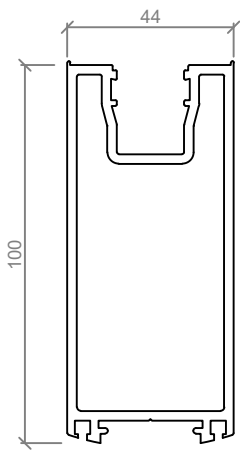

ASL 660
100mm LOCKSET STILE

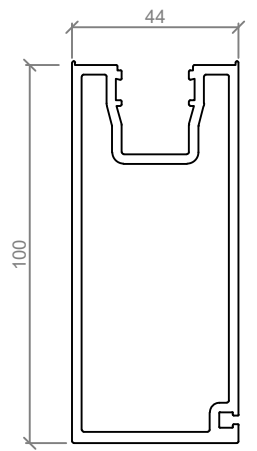

ASL 665
100mm CLOSING STILE

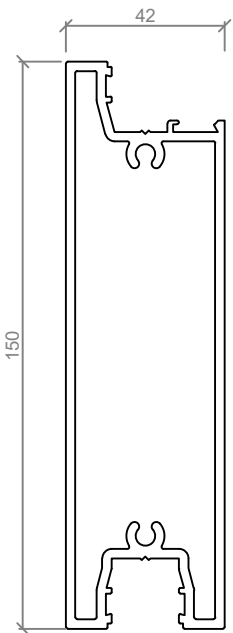

ASL 776
150mm TRANSOM & BOTTOM RAIL

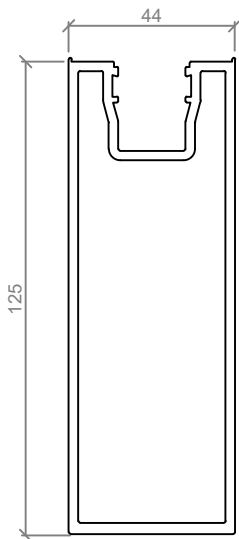

ASL 673
125mm HINGE STILE

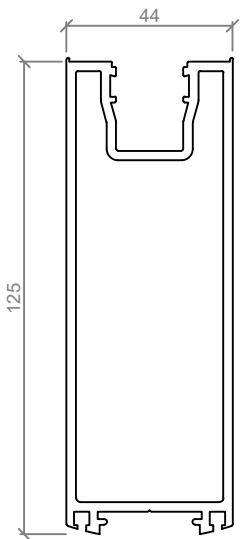

ASL 672
125mm LOCKSET STILE

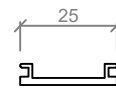

ASL 640
INFILL FOR LOCKSET STILE

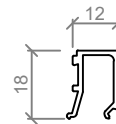

ASL 610
GLAZING BEAD

Standard Sliding Suite Profiles - Suits all ASL Systems

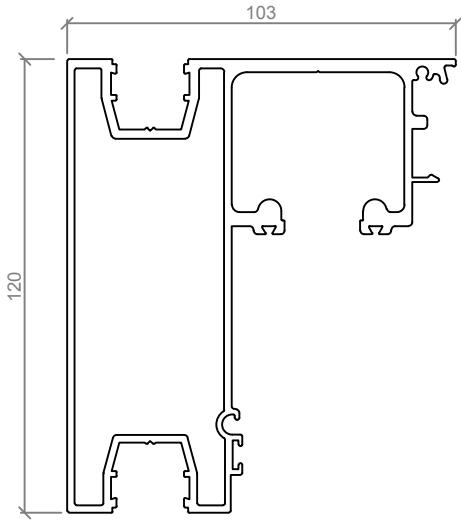

ASL 350
TOP ROLLER TRACK WITH FIXED GLAZING



ASL 351
PELMET

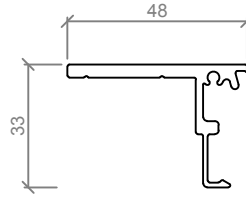

ASL 357
PELMET ADAPTER

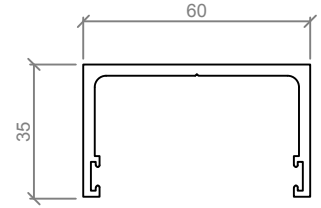

ASL 102
HEAD GUIDE

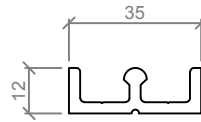

ASL 101
BOTTOM ROLLER TRACK

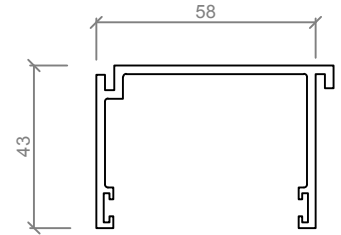

ASL 100
HEAD GUIDE (MATING)

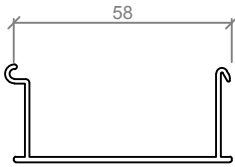

ASL 352
PELMET CLOSER

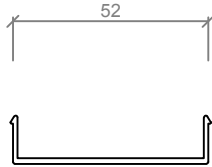

ASL 355
VERTICAL CLOSER

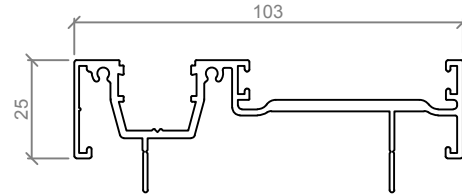

ASL 353
VERTICAL STARTER

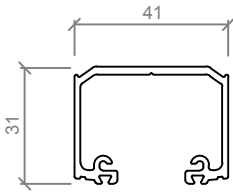

ASL 120 KG
TOP TRACK

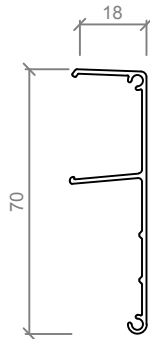

ASL 120 KG
TOP TRACK PELMET

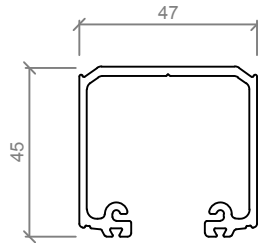

ASL 180 KG
TOP TRACK

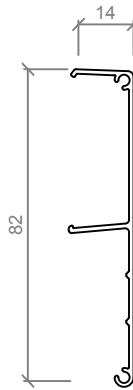

ASL 180 KG
TOP TRACK PELMET

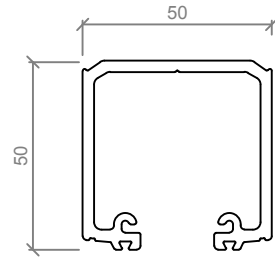

ASL 250KG
TOP TRACK

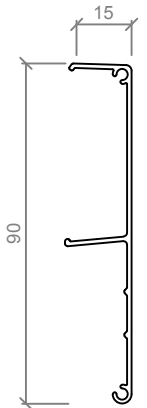

ASL 250KG
TOP TRACK PELMET

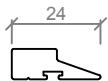

ILOCK
INTERLOCKER

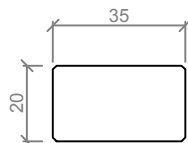

NYLON FLOOR GUIDE

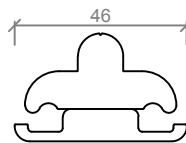

DOOR STOP 180 / 250

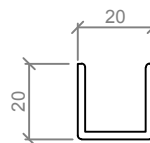

GUIDE CHANNEL

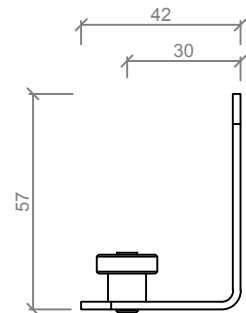

ROLLER GUIDE

Standard Elevation - 75mm Profiles

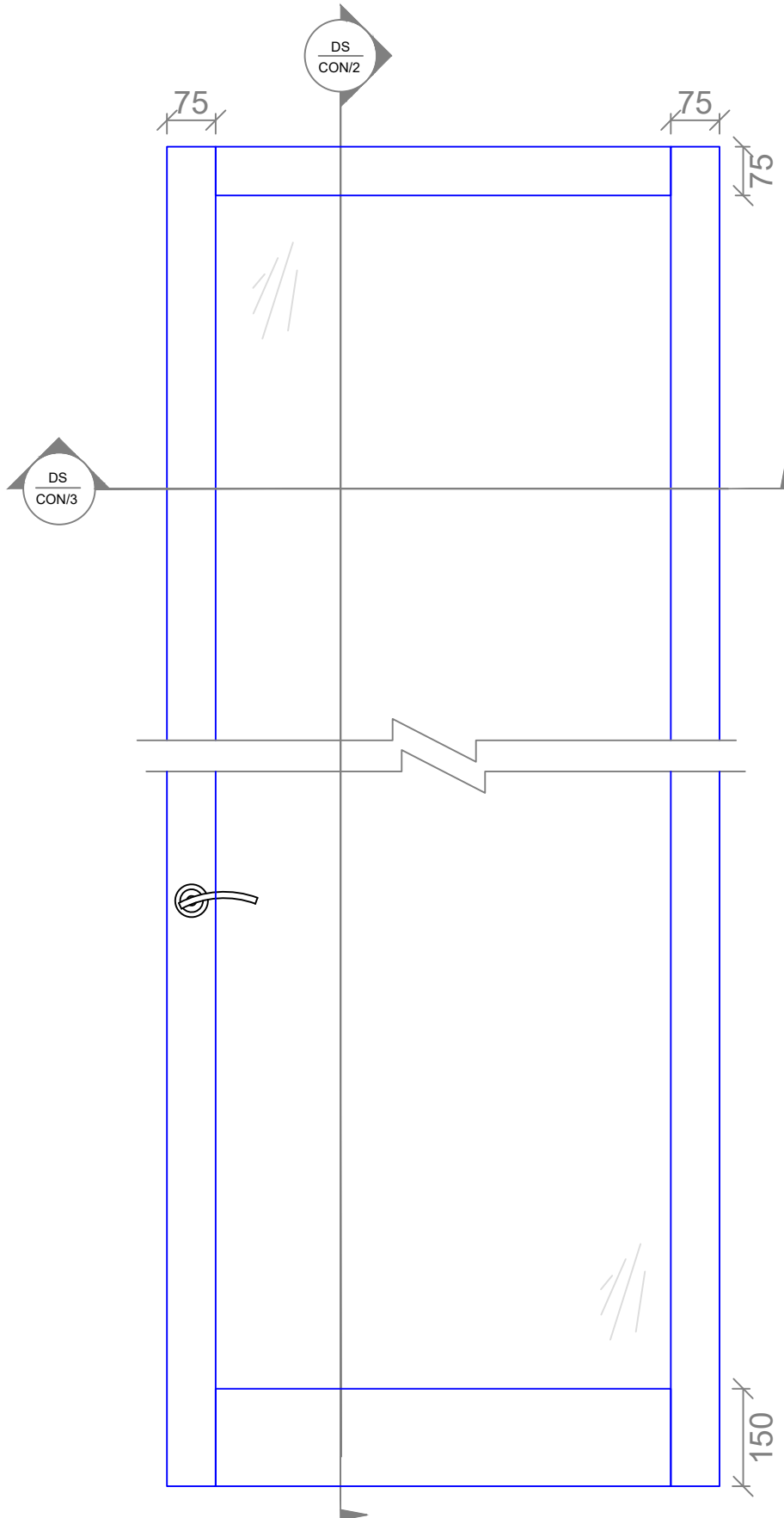

75mm Profiles - 75mm Top Rail - Vertical Options

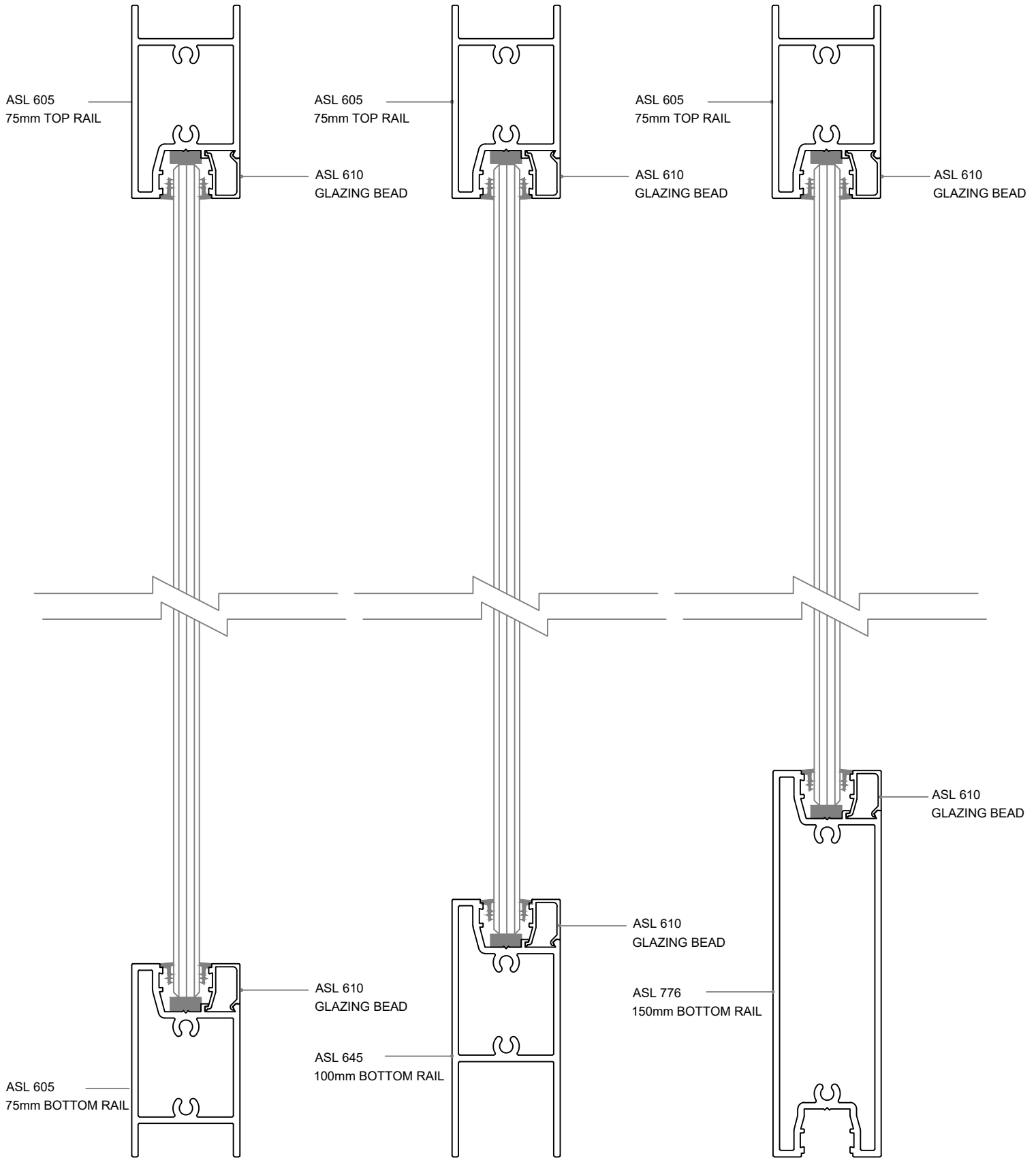

75mm Stiles - Hinged Pivot & Sliding

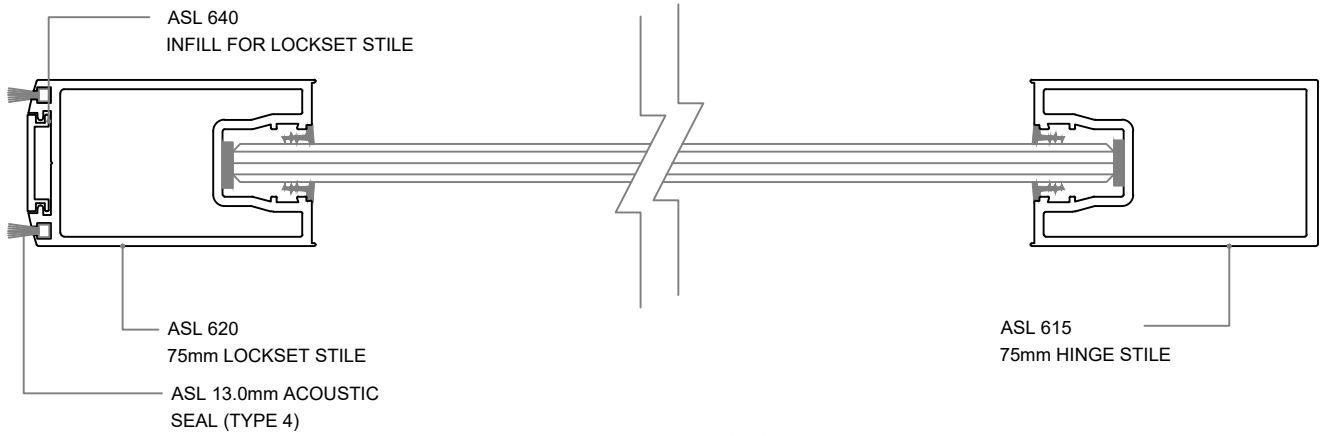

HINGED DOOR

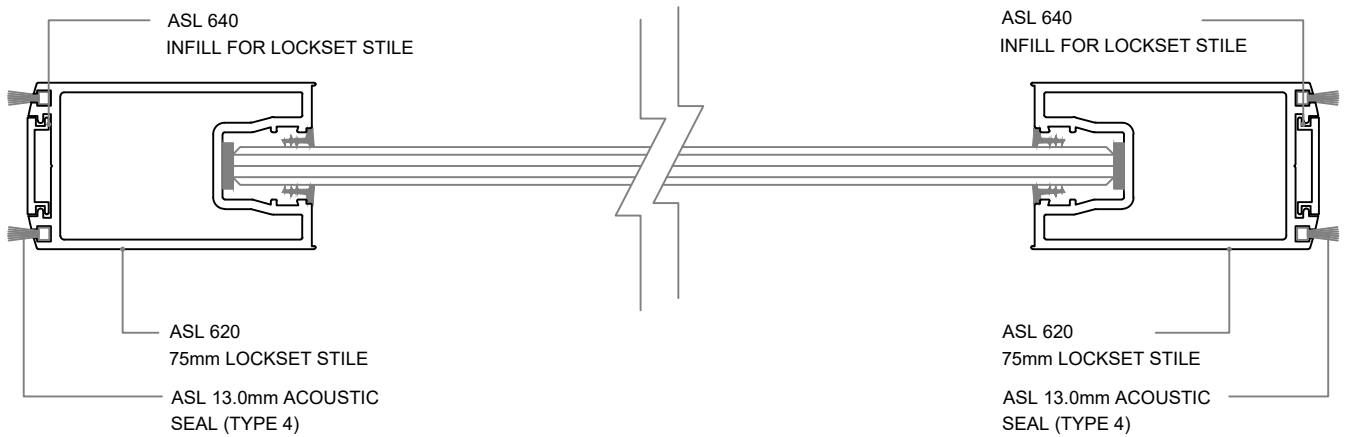

PIVOT DOOR

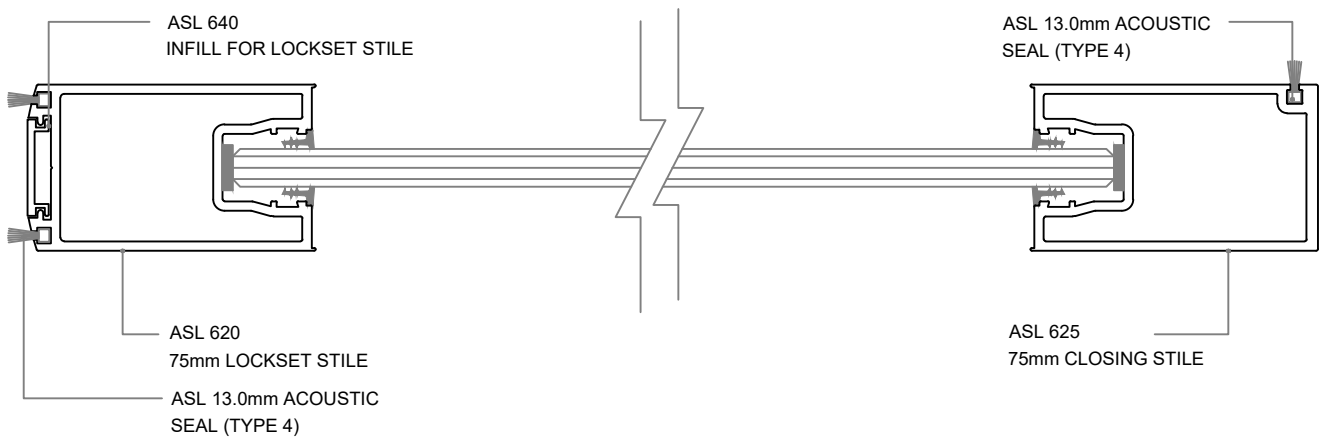

SLIDING DOOR

Standard Elevation - 100mm Profiles

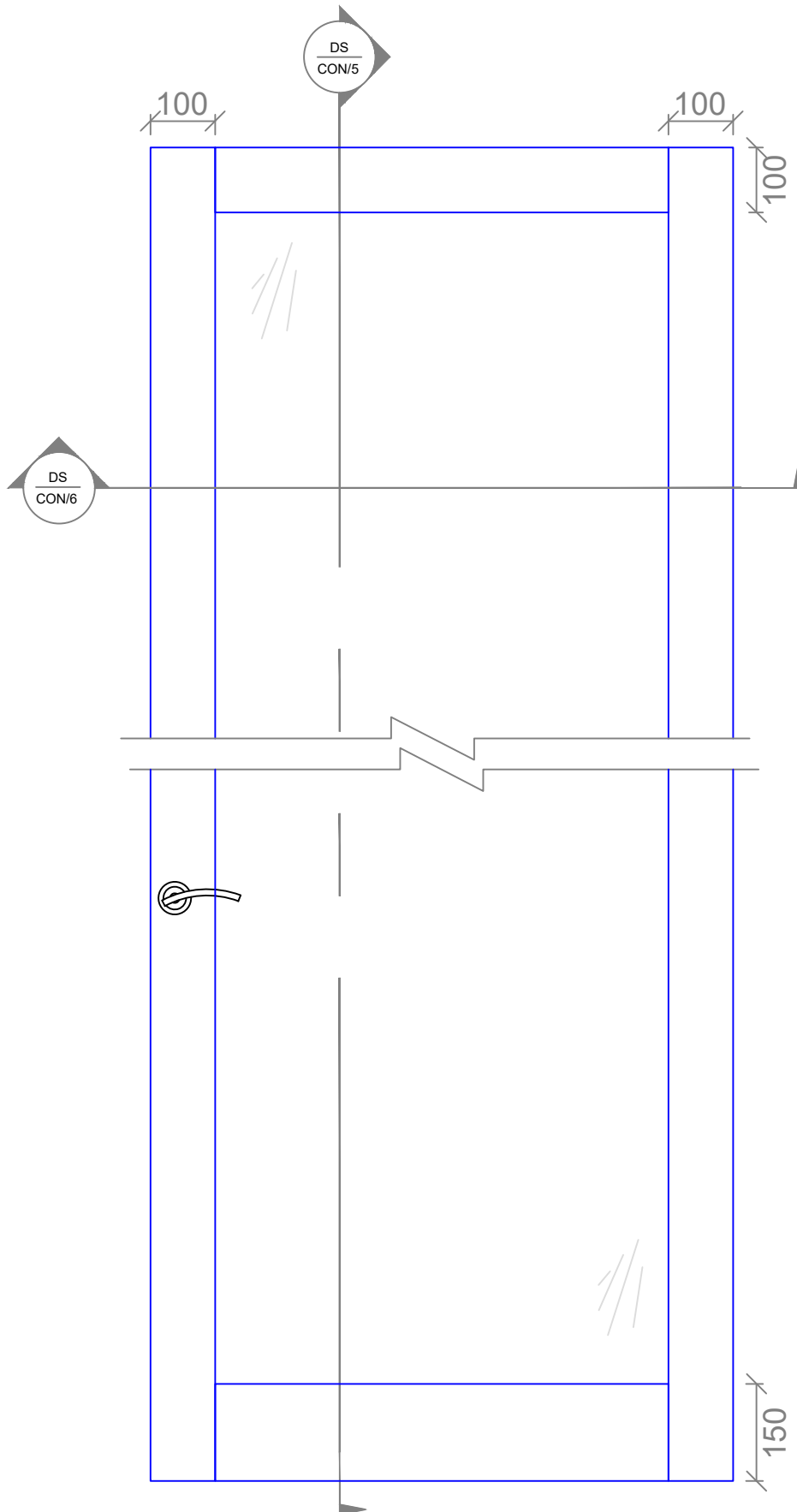

100mm Profiles - 100mm Top Rail - Vertical Options

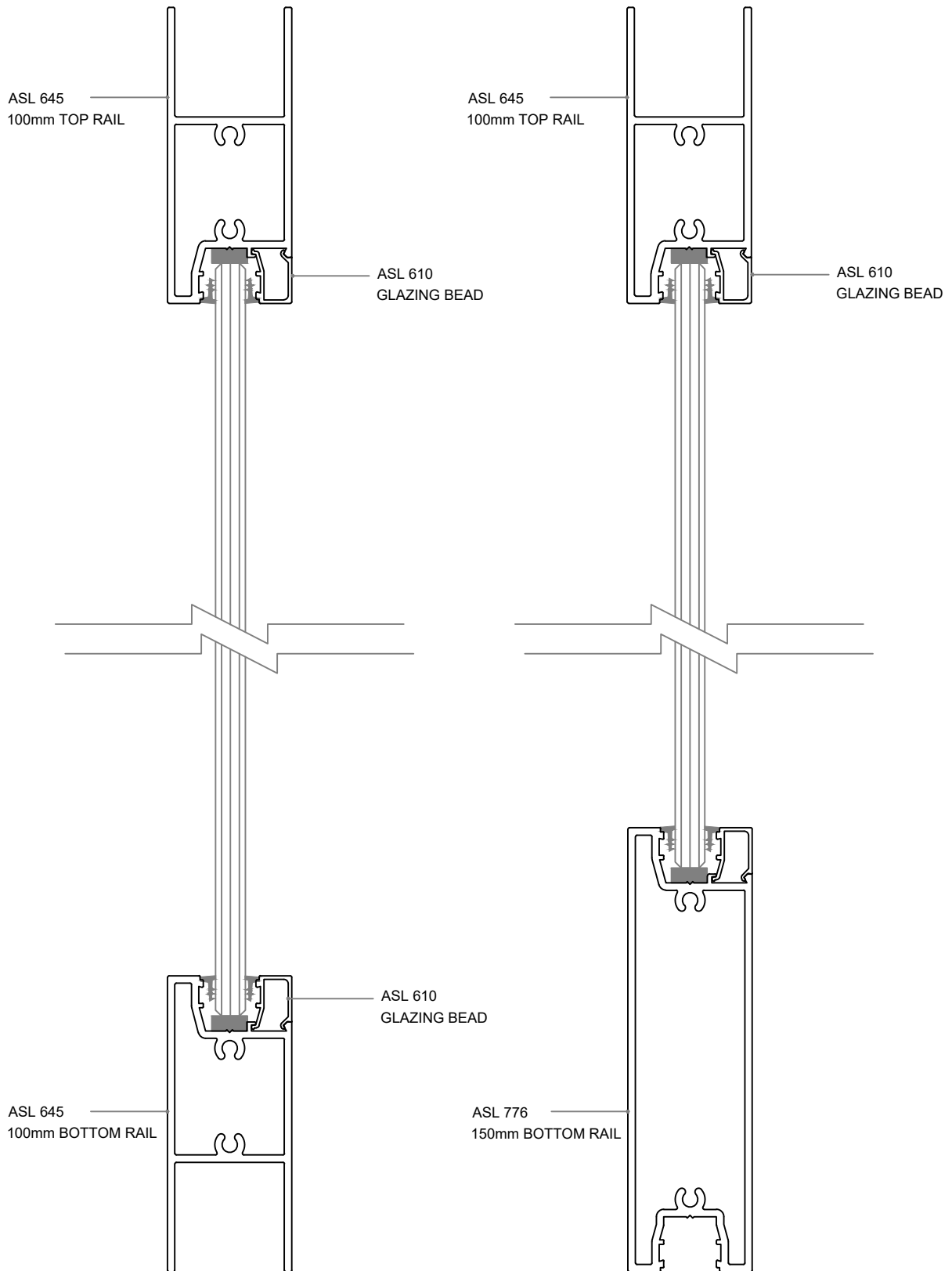

100mm Stiles - Hinged Pivot & Sliding

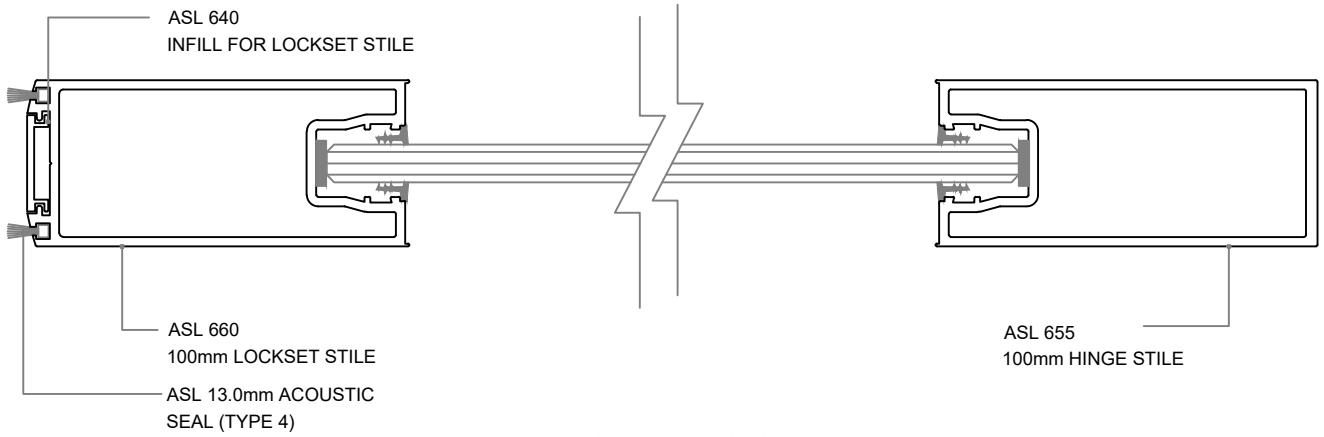

HINGED DOOR

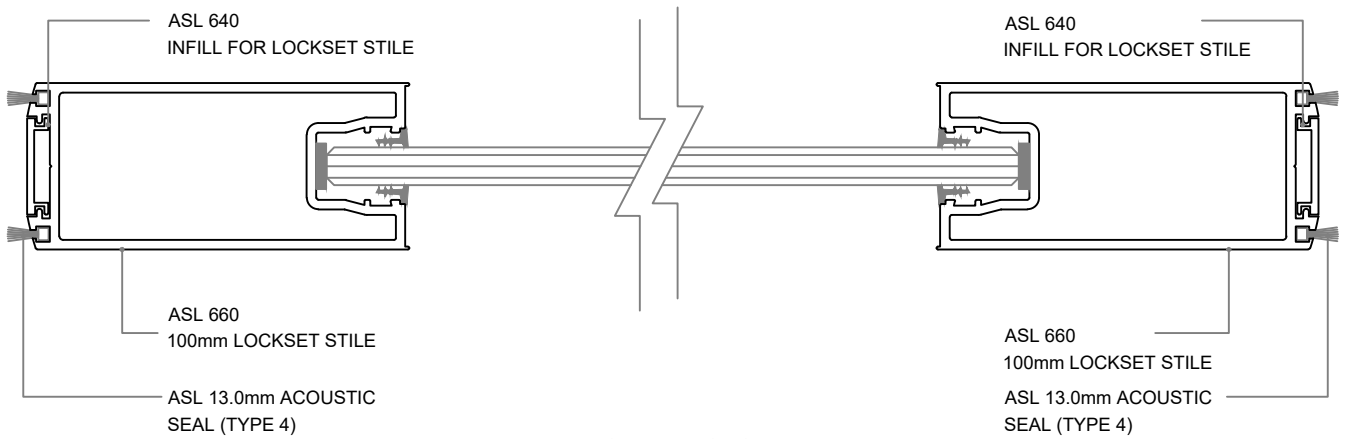

PIVOT DOOR

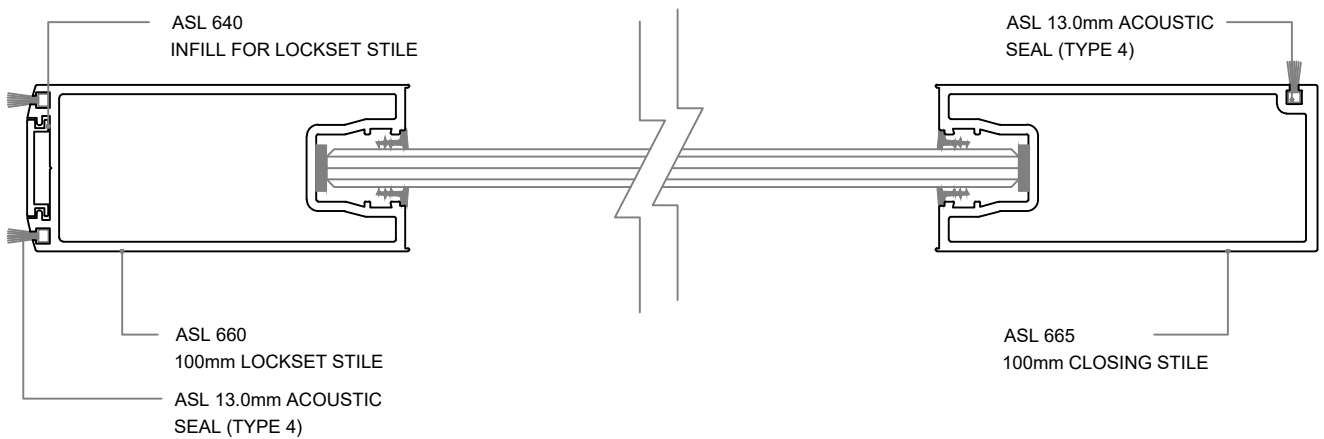

SLIDING DOOR

Standard Elevation - 125mm Profiles

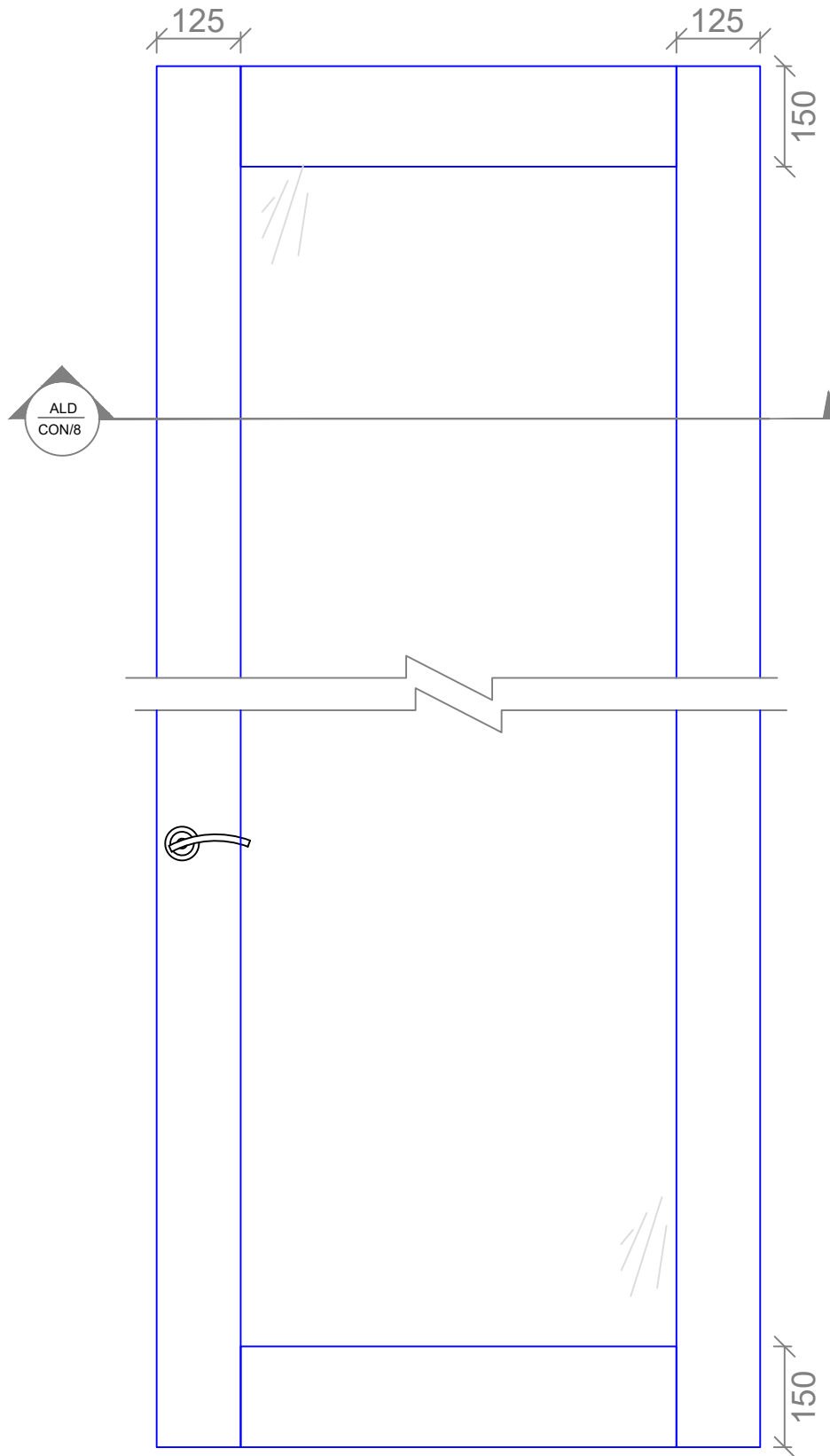

125mm Profiles - 125mm Stiles - hinged, Pivot & Sliding

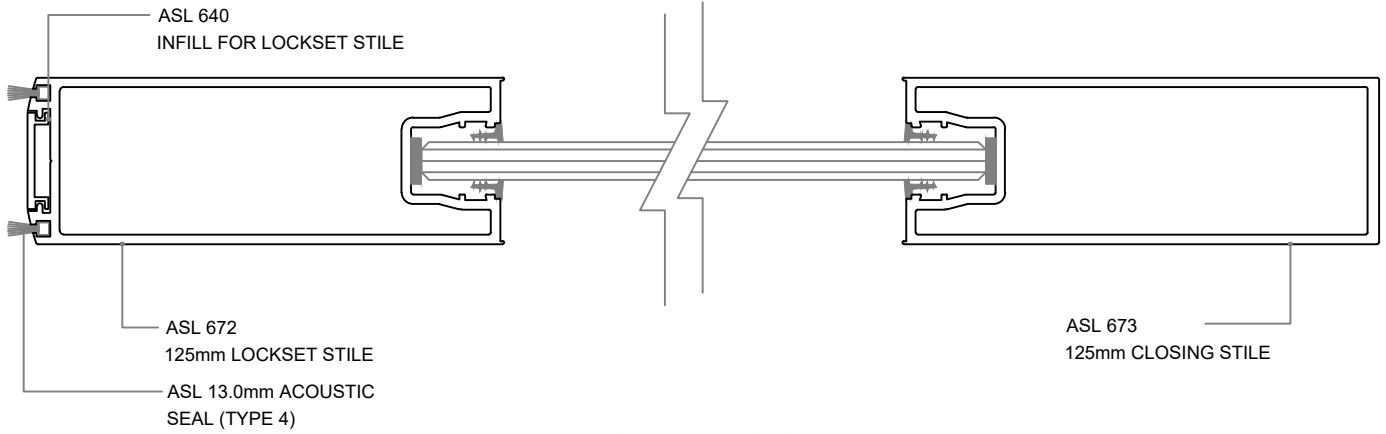

HINGED DOOR

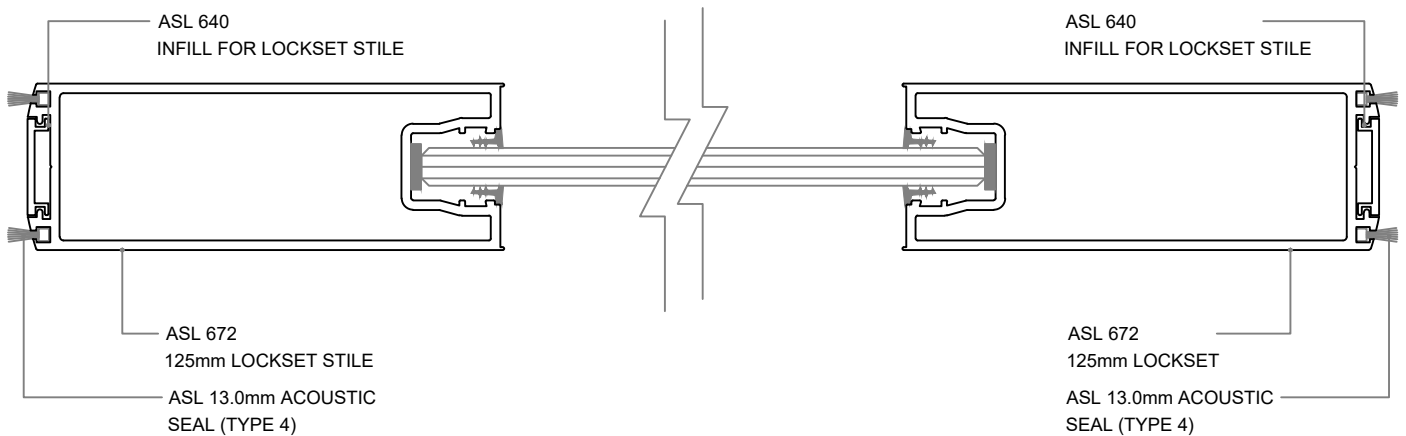

PIVOT DOOR

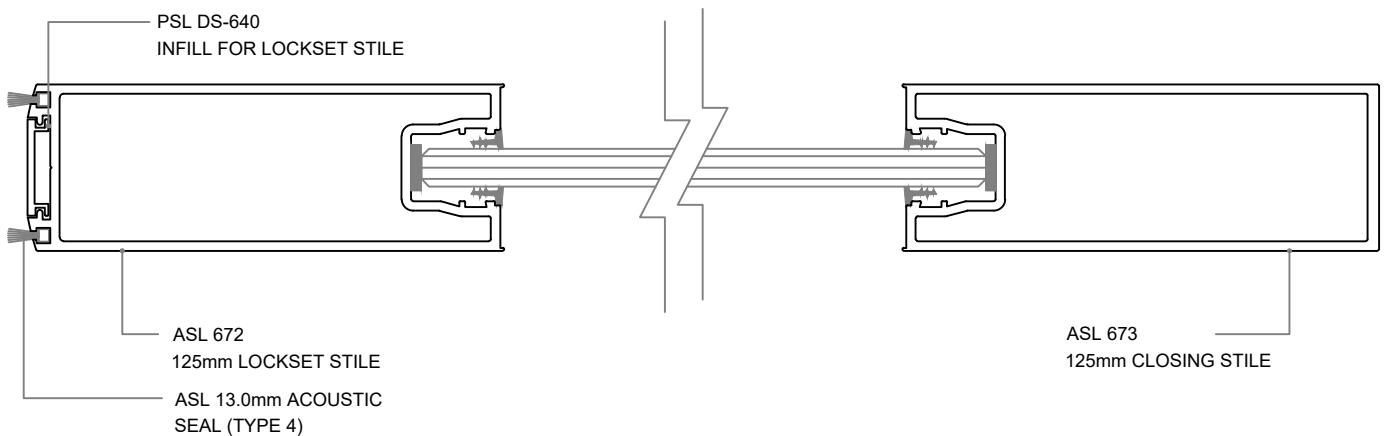

SLIDING DOOR

Standard Elevation - Single Sliding Door with Fixed Glazing

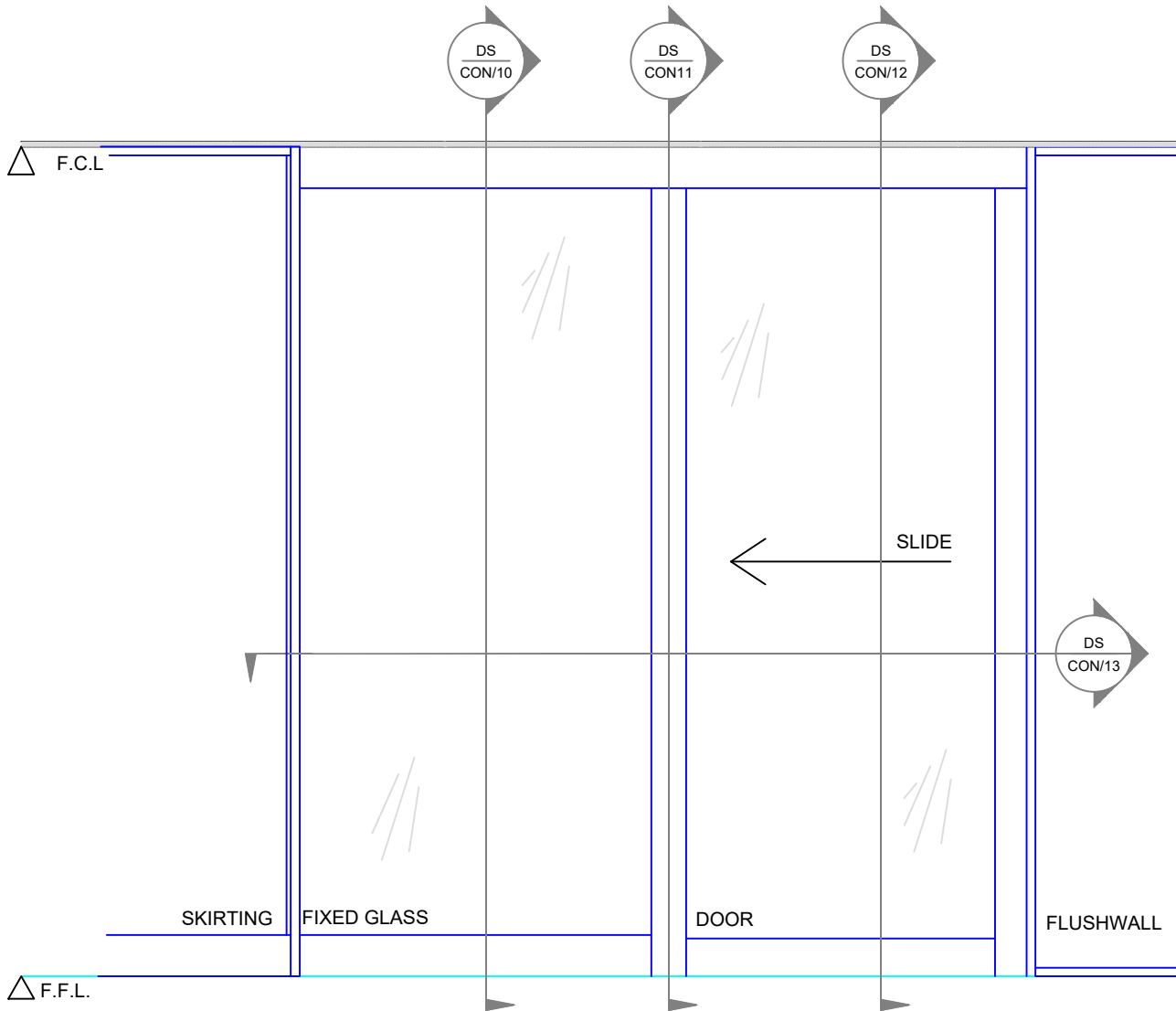

Standard Details - Top Hung Sliding Door, Fixed Panel

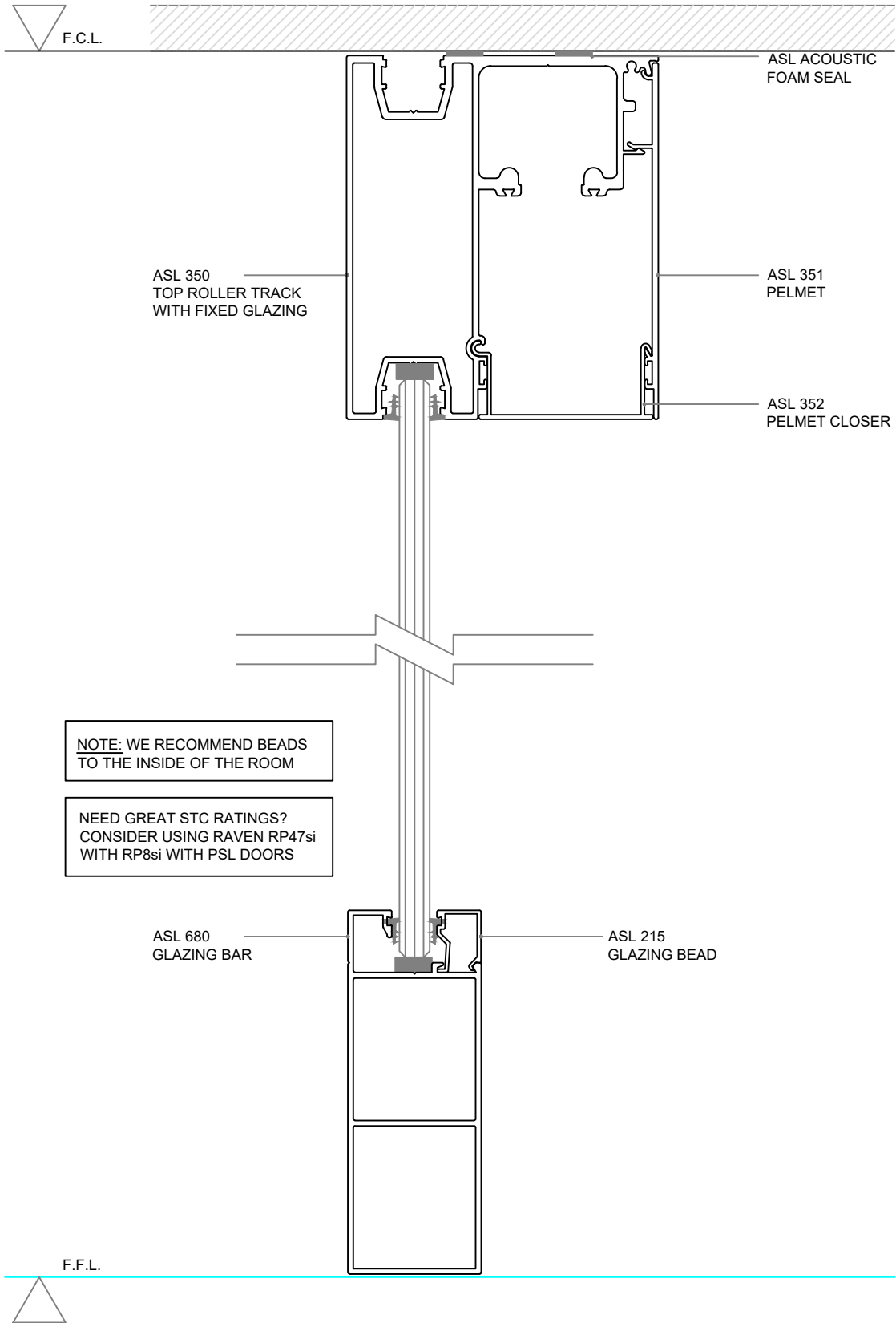

Standard Details - Top Hung Sliding Door, Fixed Panel

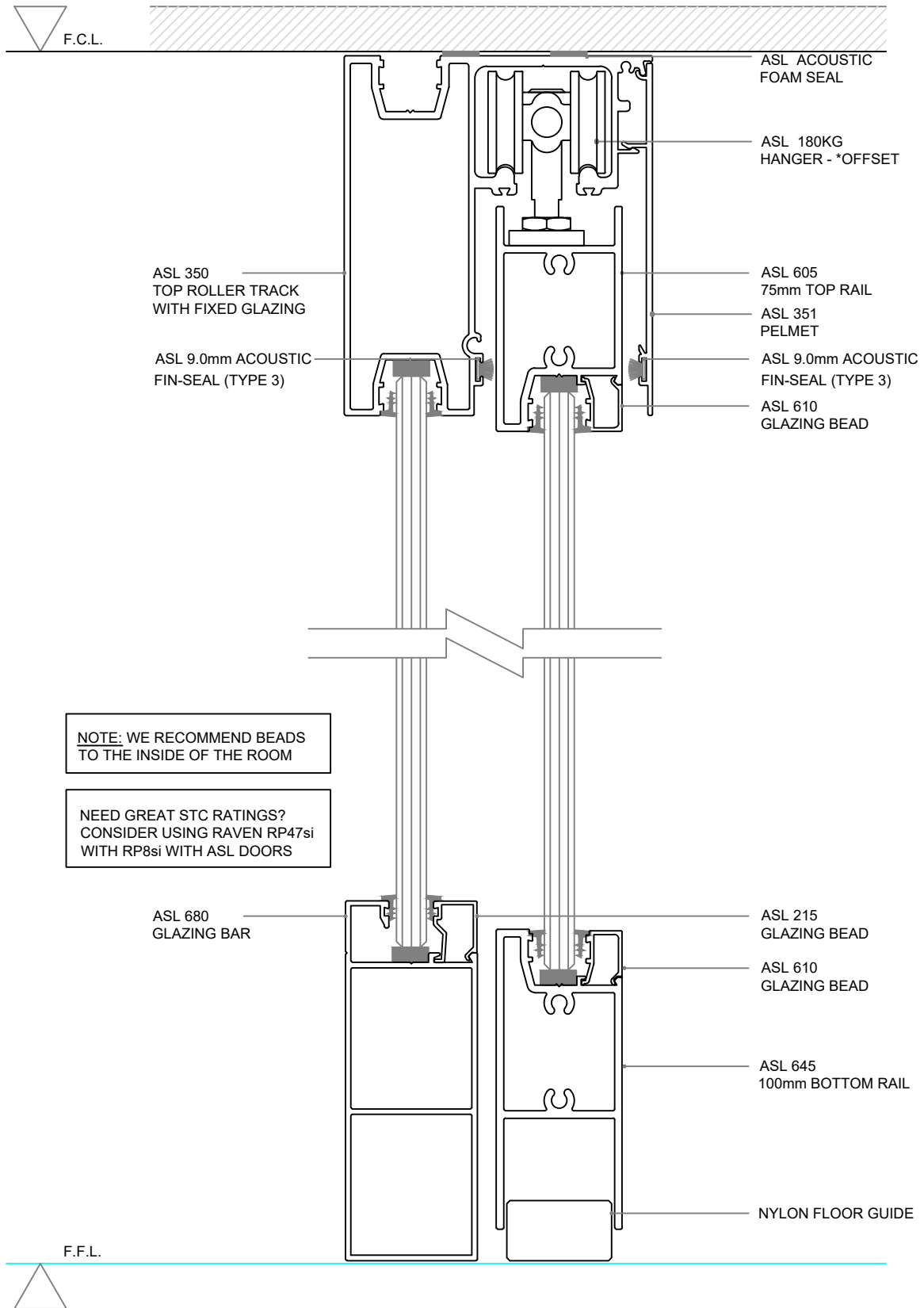

Standard Details - Opening & Door Panel

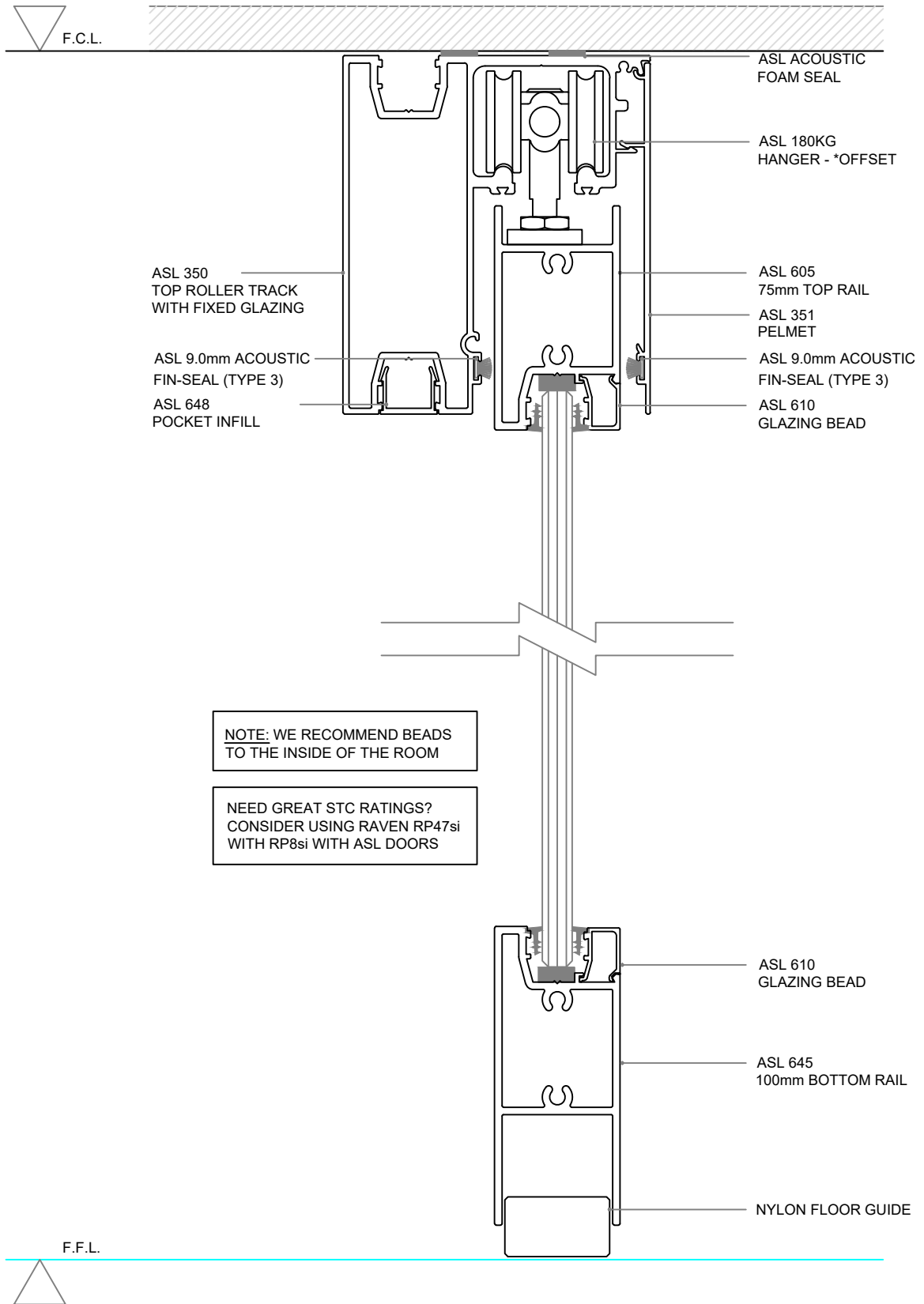

Standard Details - 64mm Steel Stud, Sliding Door, Fixed Glazing

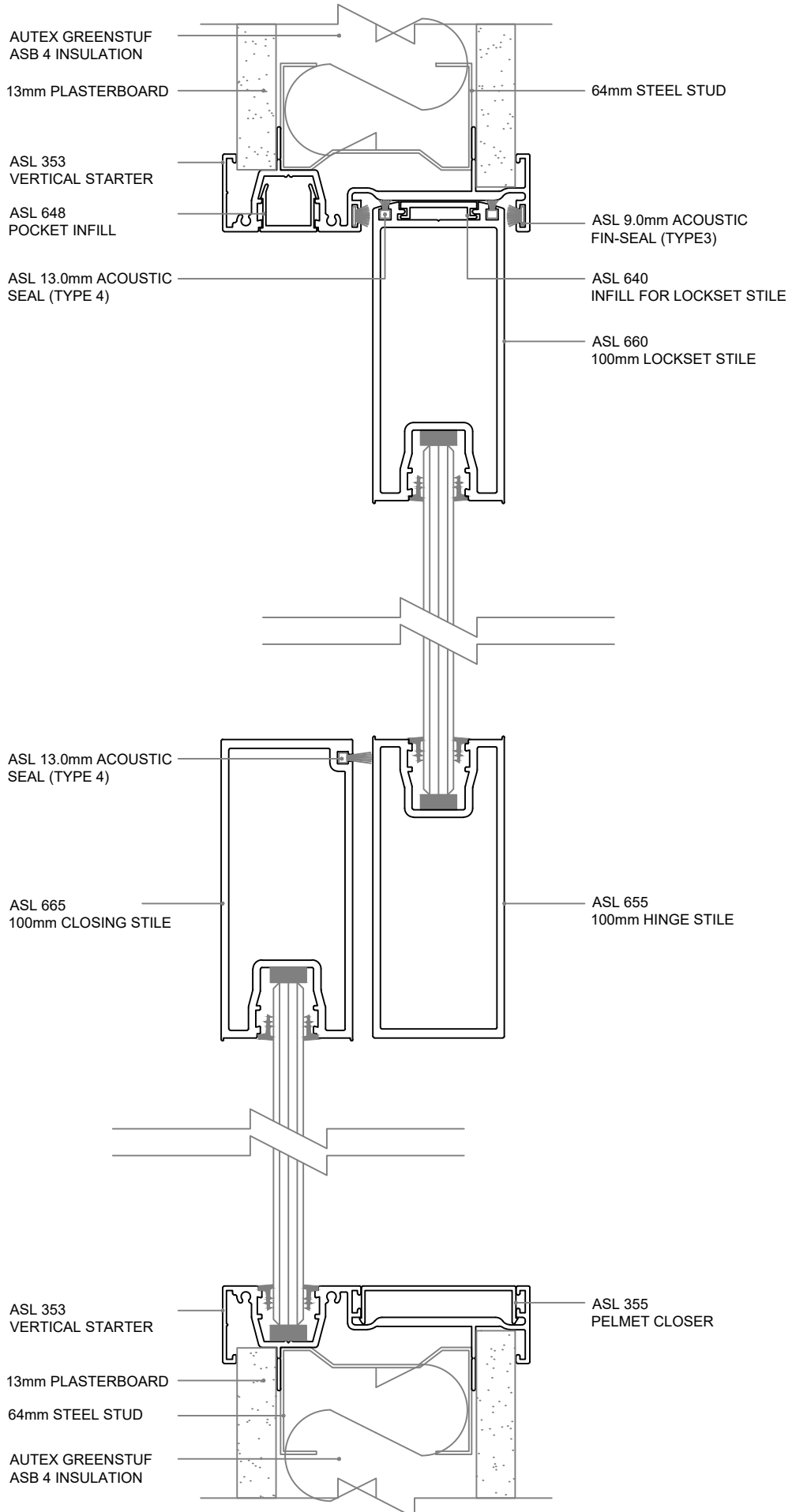

Standard Elevation - Double Sliding Doors with Fixed Glazing

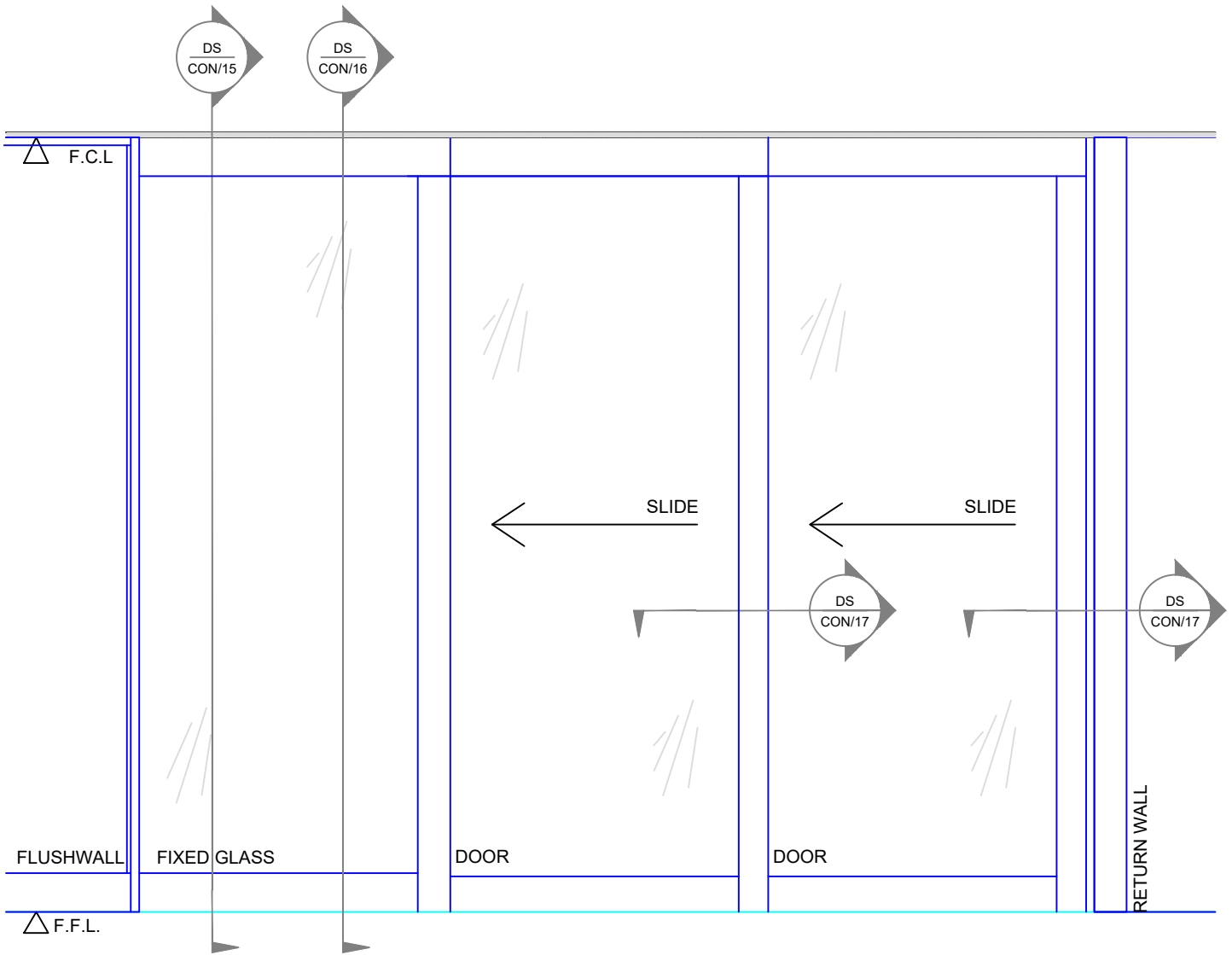

Standard Details - Bottom Roller Stacking Doors

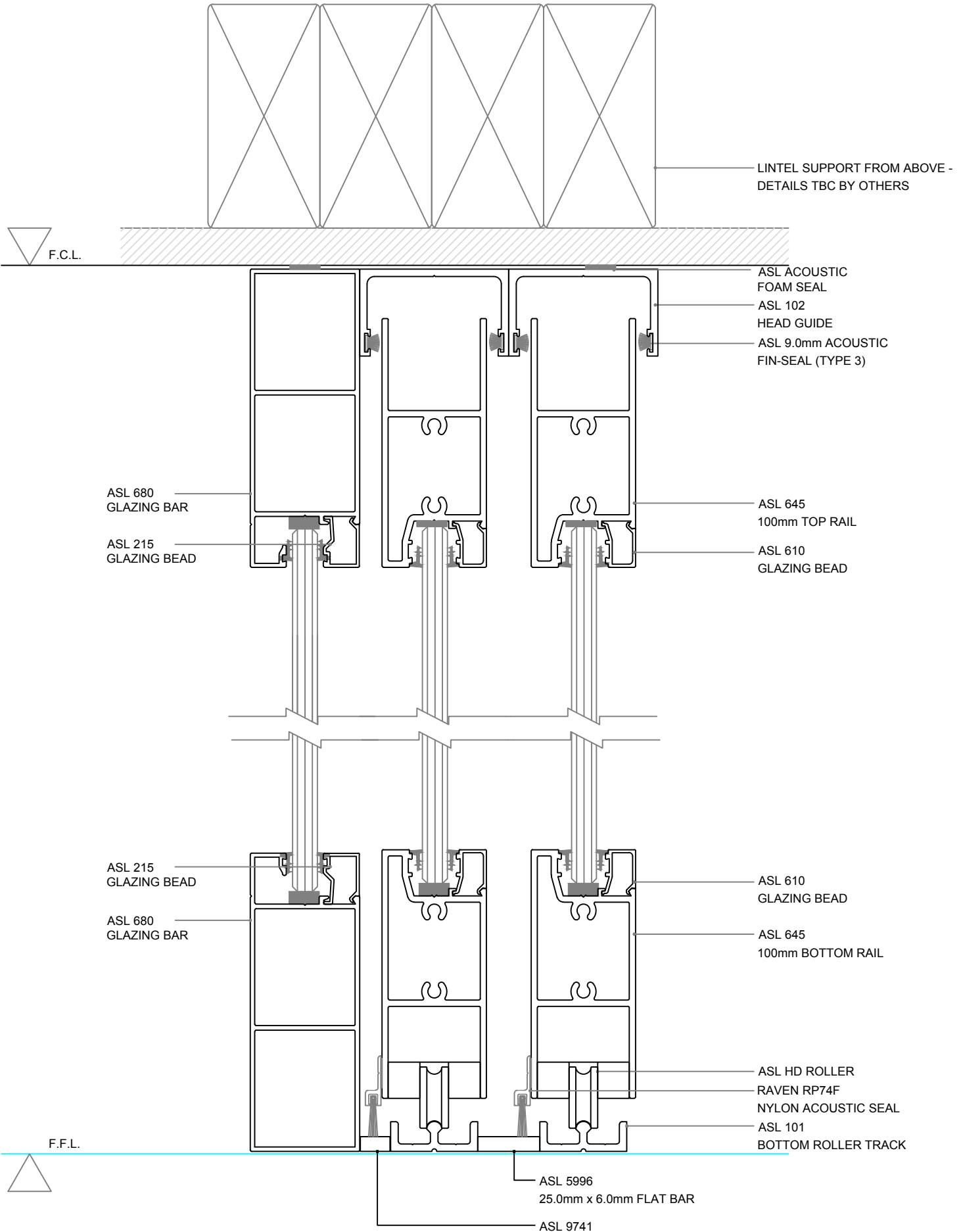

Standard Details - Bottom Roller Stacking Doors - Mating Head Guide

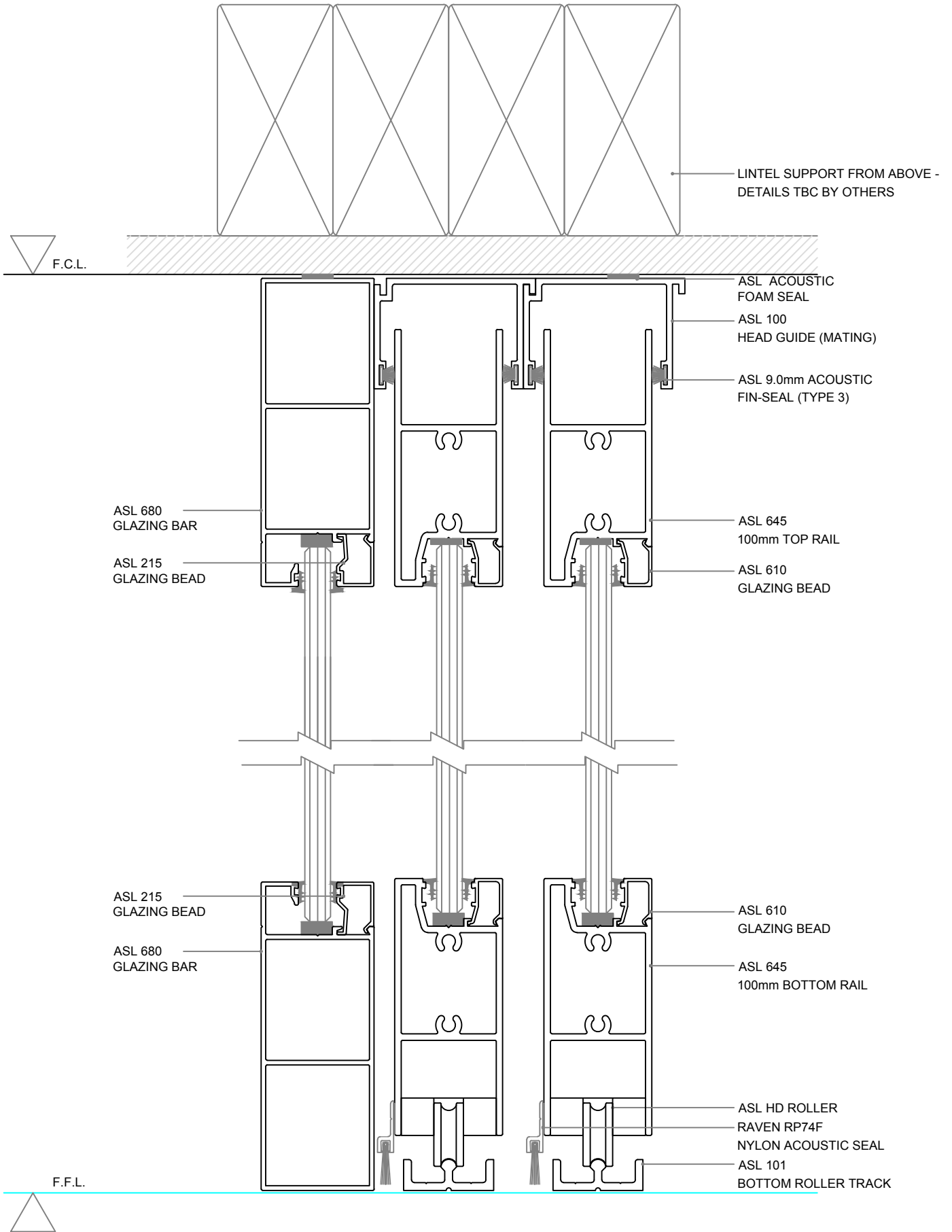

Standard Details - Vertical End Wall, Interlockers

INTERLOCKERS

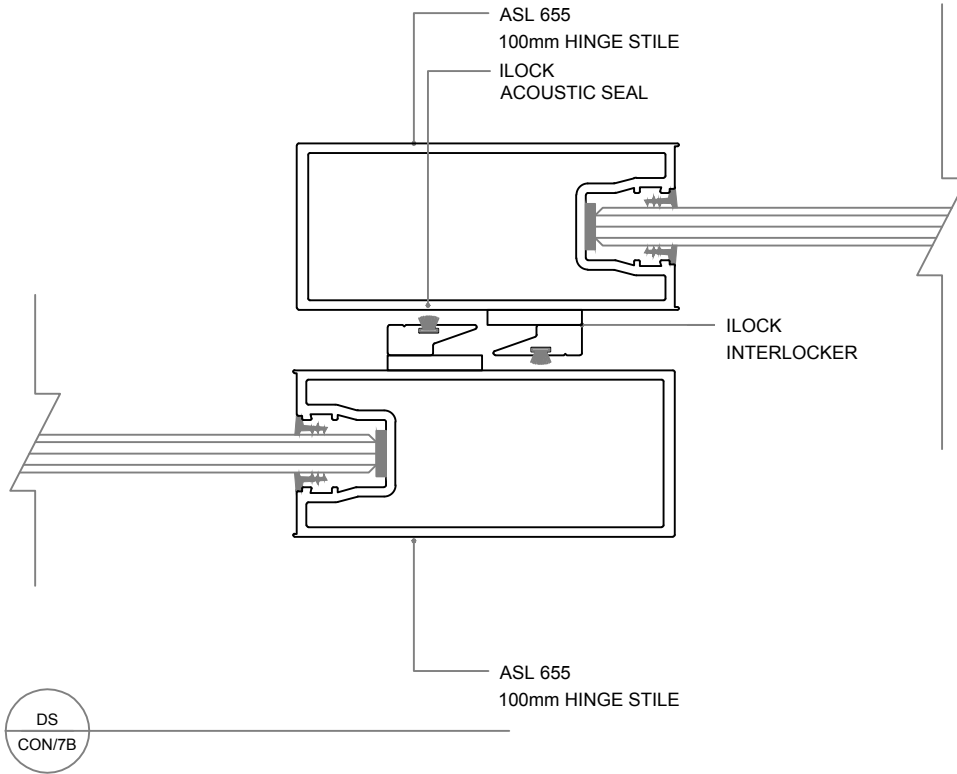

VERTICAL END WALL

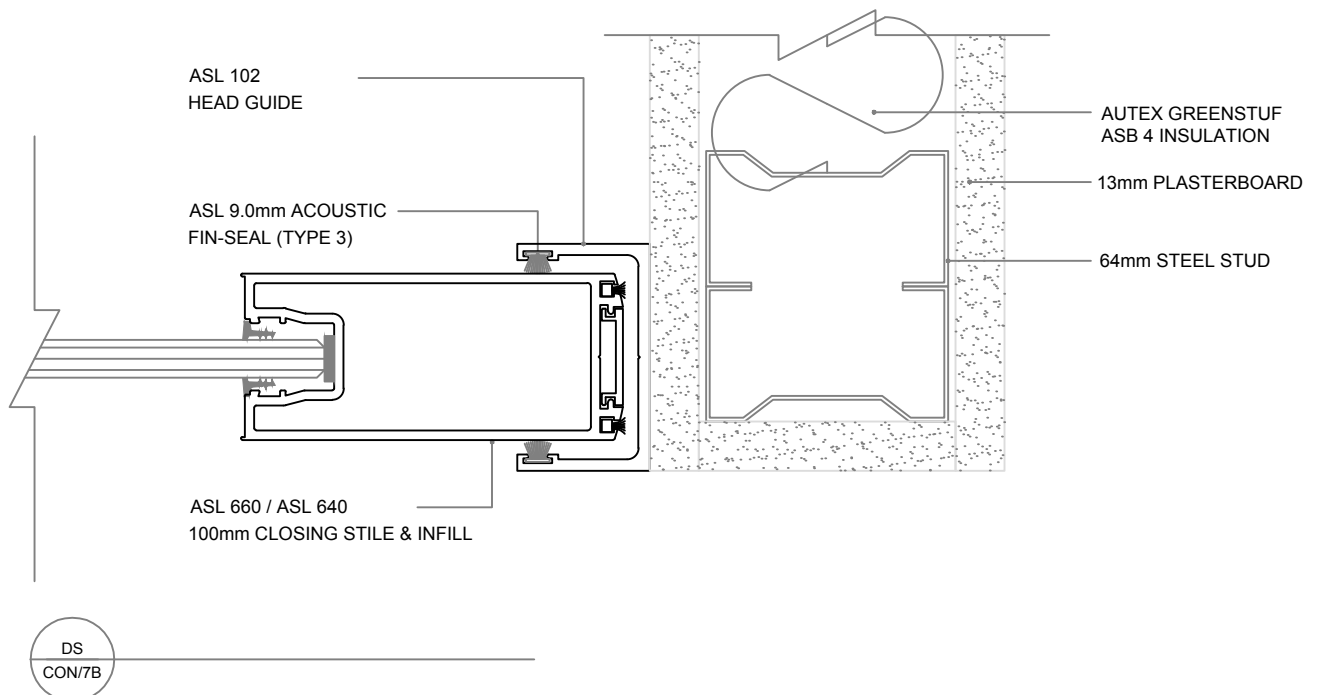

Standard Elevation - Single Sliding Door

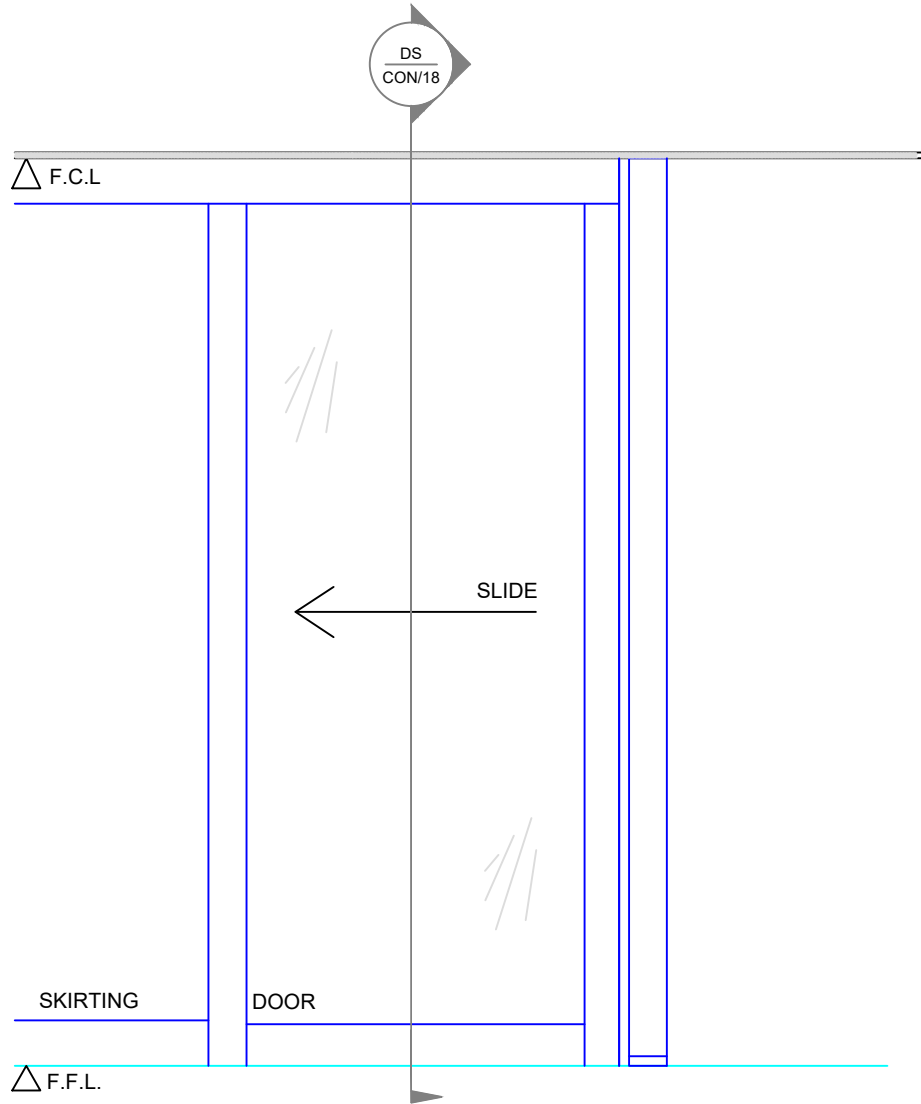

Standard Details - Single Sliding Door - Top Track

